

# Typical Drawing Layouts for Building Applications

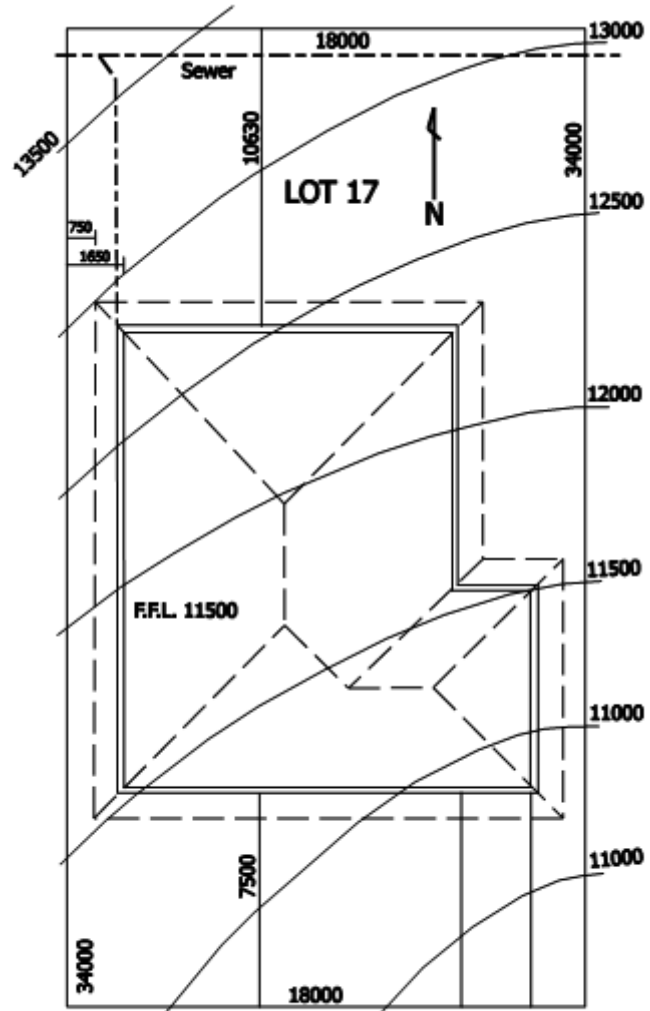

ROAD NAME Site Plan 1:200  
DATUM 10.000

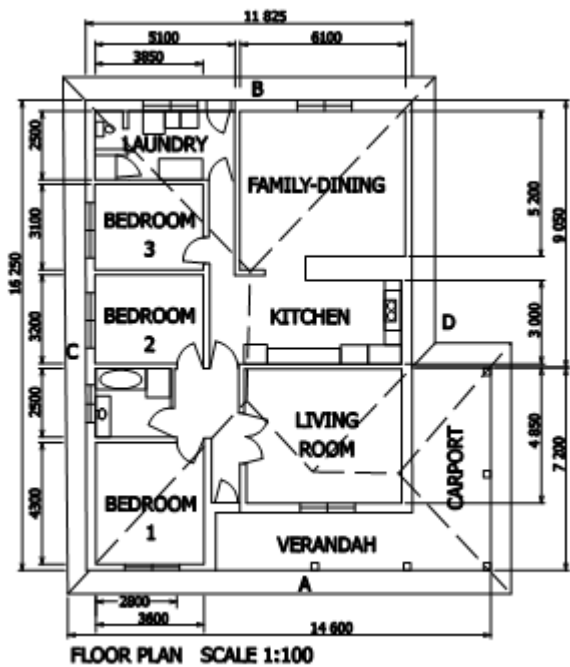

FLOOR PLAN SCALE 1:100

Typical Layout for a New Dwelling

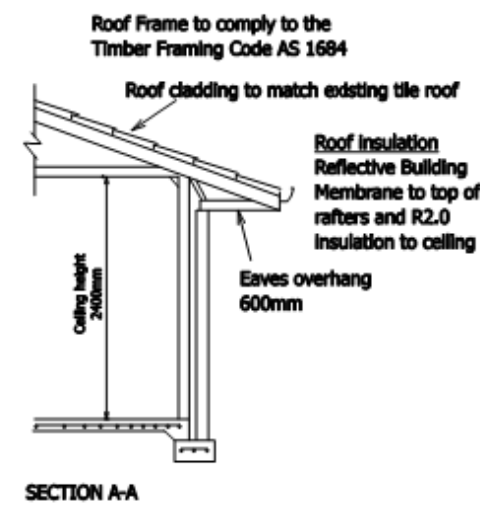
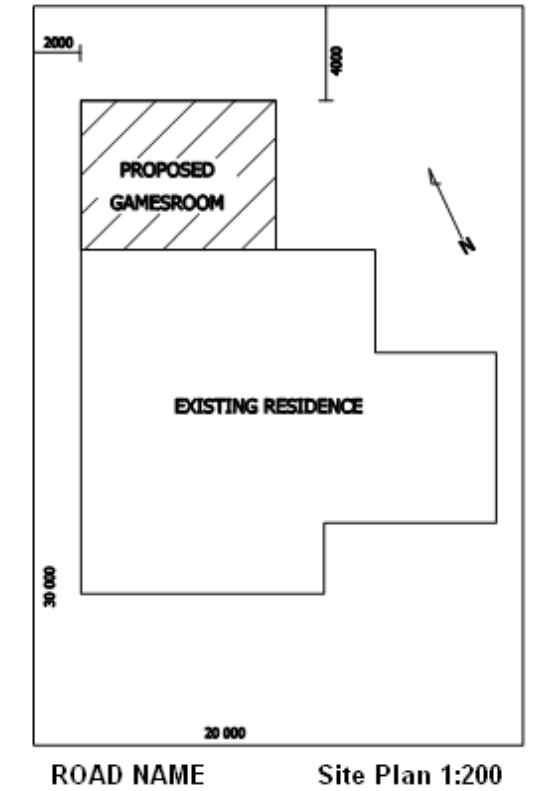
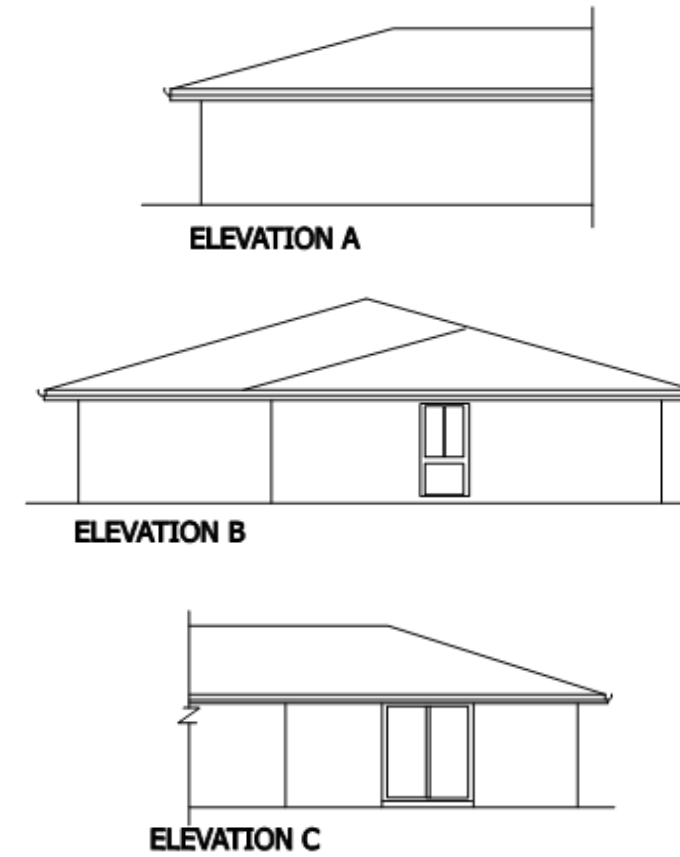
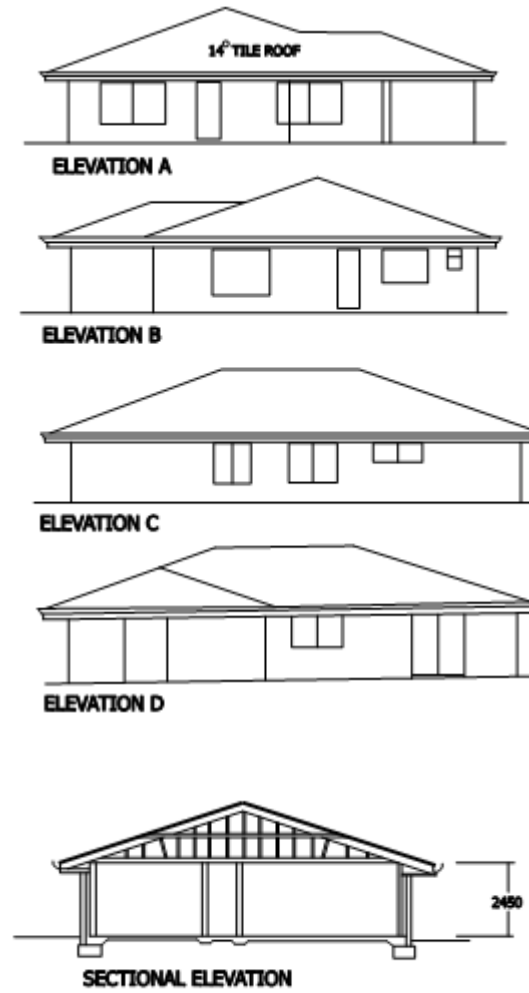

SECTION A-A

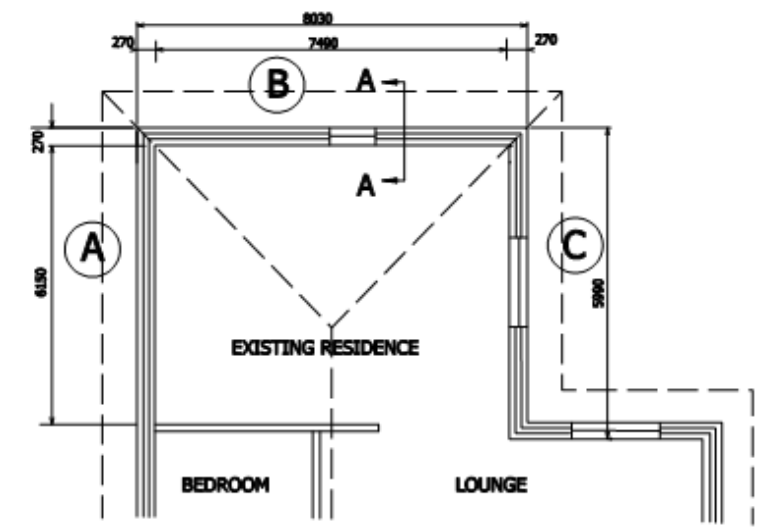

FLOOR PLAN SCALE 1:100

Typical layout for an Addition

This publication has been prepared by the City of Kalamunda as a service to its residents. The material contained in this document is intended to help you to understand the rules and regulations. It does not purport to, nor is it intended to, constitute legal advice. It is provided in good faith as a public service. However, the City does not guarantee the accuracy of any of the information provided or of any statements made and it is the responsibility of readers to make their own enquiries as to the accuracy, currency and appropriateness of any information or advice provided. The City expressly disclaims liability, whether in negligence or otherwise, for any act or omission resulting from reliance on this document or for any consequence of such act or omission.

2 Railway Road, Kalamunda WA 6076  
PO Box 42, Kalamunda WA 6926  
P: (08) 9257 9999  
F: (08) 9293 2715  
E: [enquiries@kalamunda.wa.gov.au](mailto:enquiries@kalamunda.wa.gov.au)  
W: [www.kalamunda.wa.gov.au](http://www.kalamunda.wa.gov.au)